

1. Use tracing paper for these questions.

a) Rotate **A** 90° clockwise about the star (*)

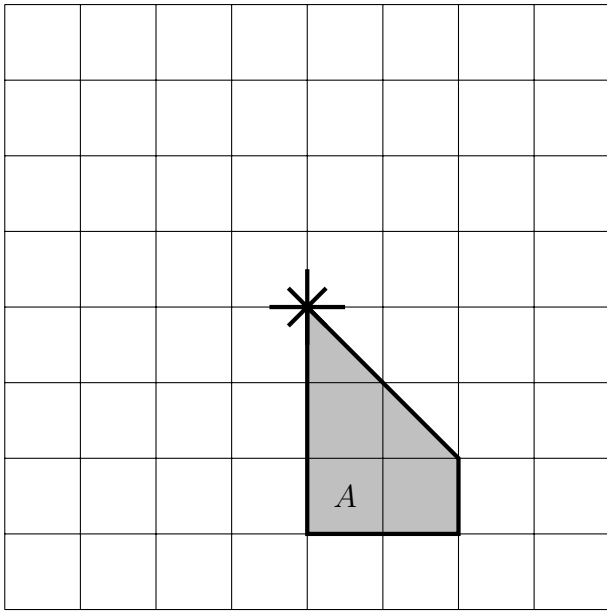

b) Rotate **B** 90° anti-clockwise about the star (*)

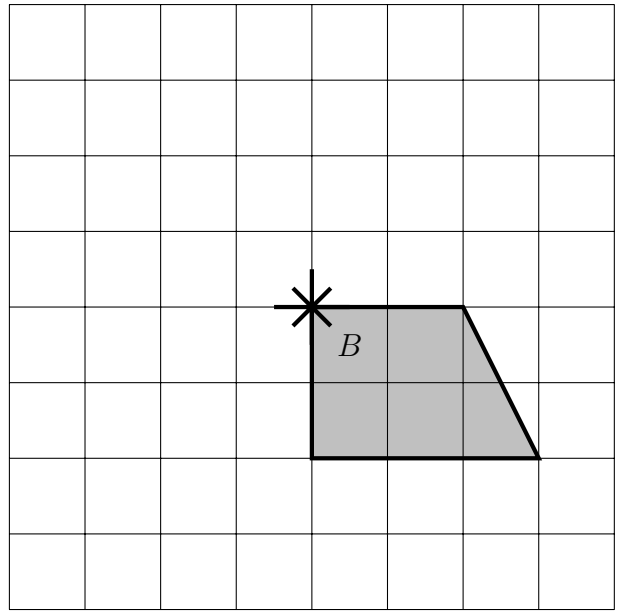

c) Rotate **C** 90° clockwise about the star (*)

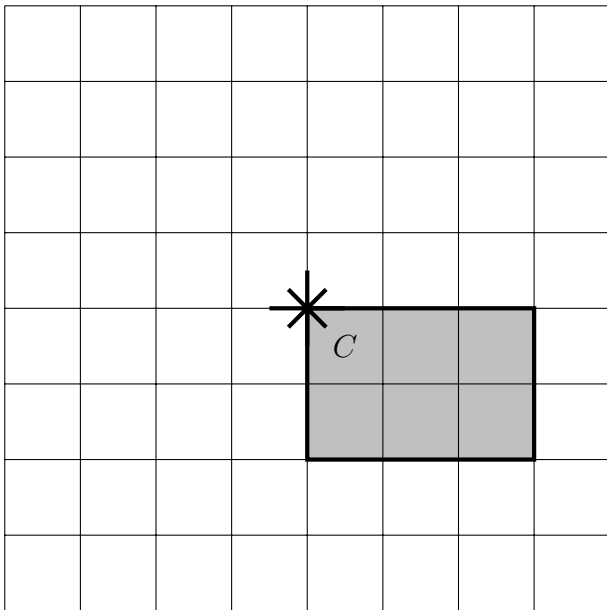

d) Rotate **D** 90° anti-clockwise about the star (*)

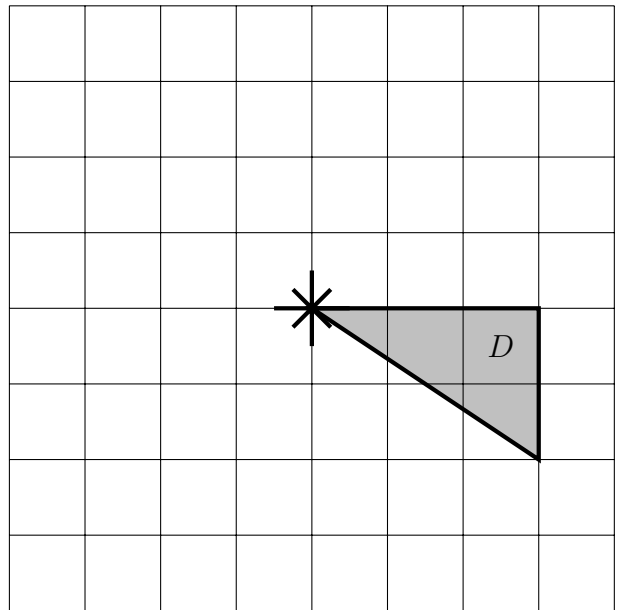

Answers

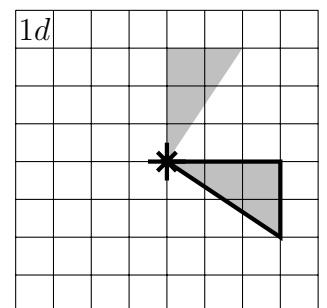
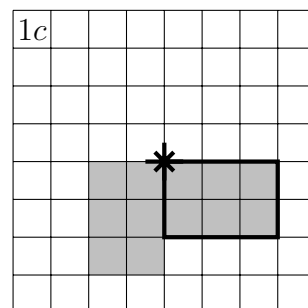
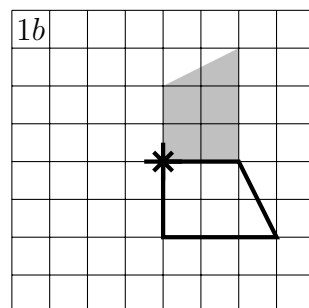
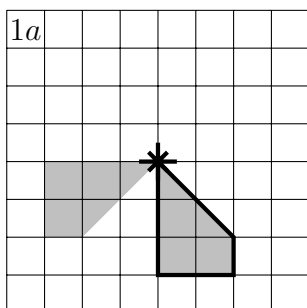

Turn over for more questions and answers

2.

a) Rotate **A** 90° anti-clockwise about the star (*)

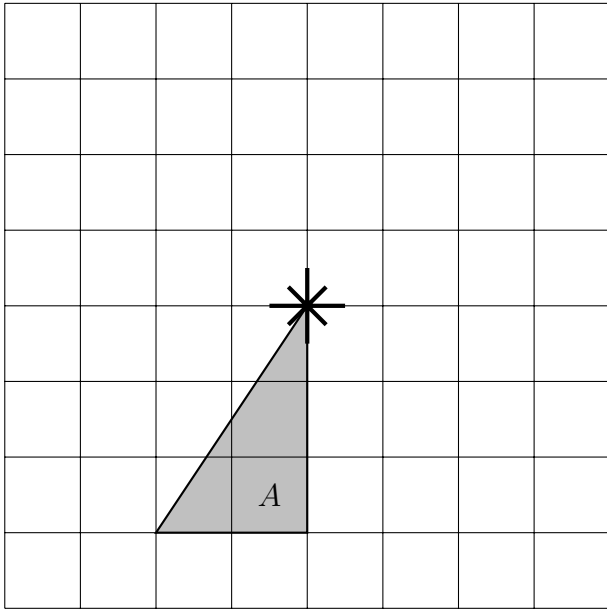

b) Rotate **B** 90° clockwise about the star (*)

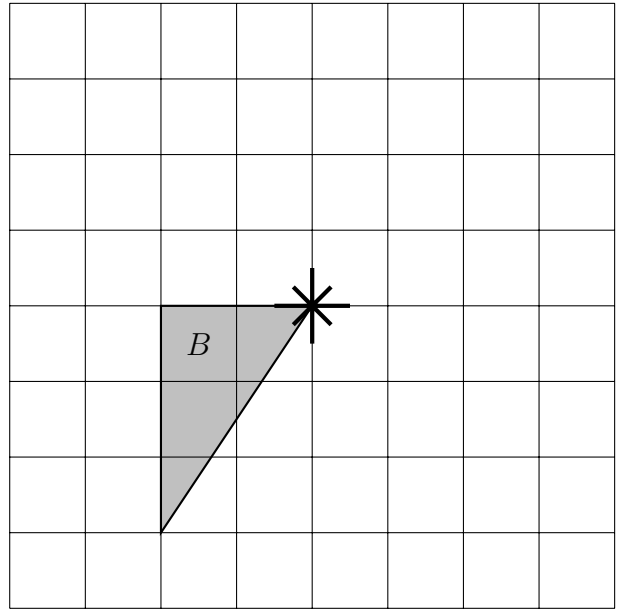

c) Rotate **C** 90° clockwise about the star (*)

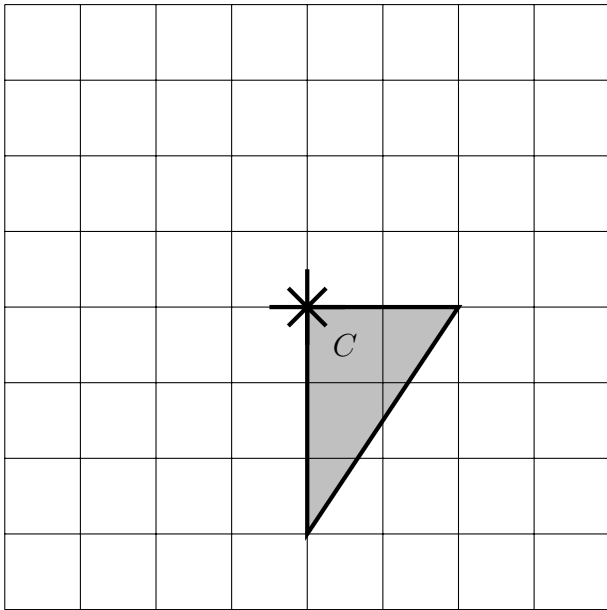

d) Rotate **D** 90° anti-clockwise about the star (*)

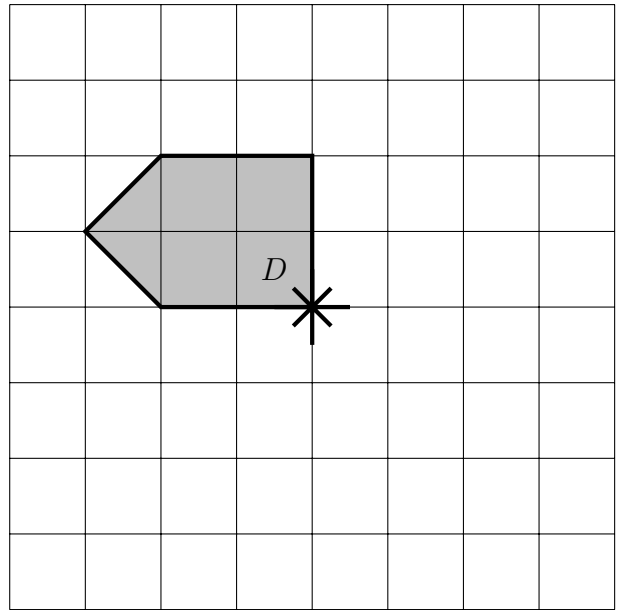

Answers

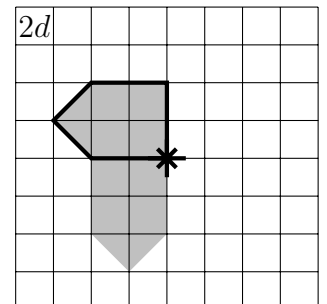
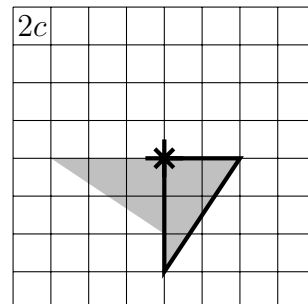
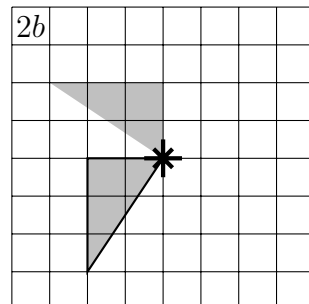
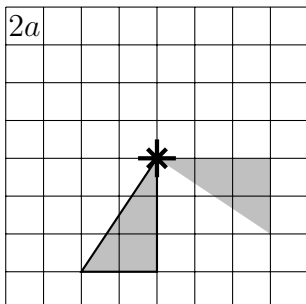

(turn back over for answers to question 1)